

A LITTLE BIT MORE

SMART.POINT System

OLIGO Lichttechnik GmbH
Tannenweg 1
DE - 53757 Sankt Augustin
Germany
www.oligo.de
info@oligo.de

Art.-Nr. / Item-No.

20-882-4x-YY 2700K







20-882-5x-YY 3000K

20-882-6x-YY 4000K

(D)	Leuchtmittel nicht ersetzbar
(GB)	Bulbs not replaceable
(NL)	Lamp niet vervangbaar
(F)	Ampoules non remplaçables
(I)	Lampadina non sostituibile
(ES)	Bombillas no reemplazables
(P)	Lâmpada não substituível
(DK)	Ljuskällorna kan inte bytas ut

(S)	Bulb inte utbytbara
(N)	Lyspærer kan ikke skiftes ut
(FI)	Valistusvälinettä ei voi vaihtaa
(TR)	Ampuller değiştirilemez
(PL)	Źródło światła nie jest wymienne
(GR)	Οι λαμπτήρες δεν αντικαθίστανται
(RUS)	Светодиоды не поддаются замене
(UAE)	تجهيزات الإضاءة غير قابلة للاستبدال

	DC 24V	11W	LED/ CRI - RA >90 / 1000 lm
(D)	Spannung	Belastung	Lampe
(GB)	Voltage	Loading	Bulb
(NL)	Spanning	Belasting	Verlichtingsmiddel
(F)	Tension	Charge	Ampoule
(I)	Tensione	Carico	Sorgente luminosa
(ES)	Tensión	Carga	Lámpara
(P)	Tensão	Carga	Lâmpada
(DK)	Spænding	Belastning	Pære
(S)	Spänning	Belastning	Ljuskälla
(N)	Spenning	Fatning	Lampe
(FI)	Jännite	Kuormitus	Lamppu
(TR)	Gerilim	Yük	Lamba
(PL)	Napięcie	Oprawka	Lampa
(GR)	Τάση	Υποδοχή	Λαμπτήρας
(RUS)	Напряжение	Нагрузка	Лампочка
(UAE)	الجهد الكهربائي	الدواة	المصباح

	
IEC 62471 (EN 62471)	
RG1 - LOW RISK	
	
option	OC PWM
HomeMatic	
CASAMBI	
	

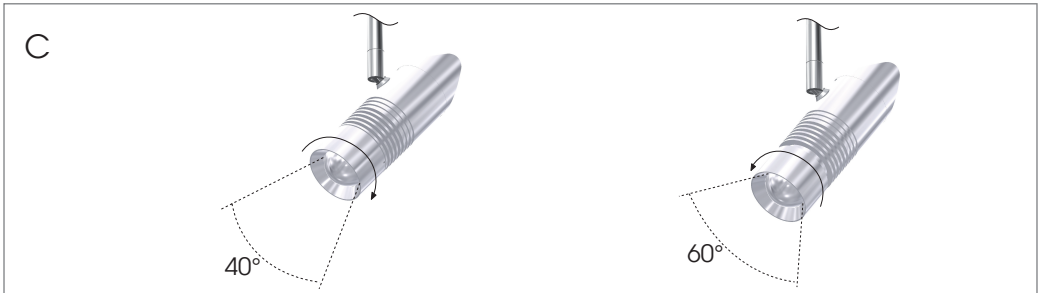
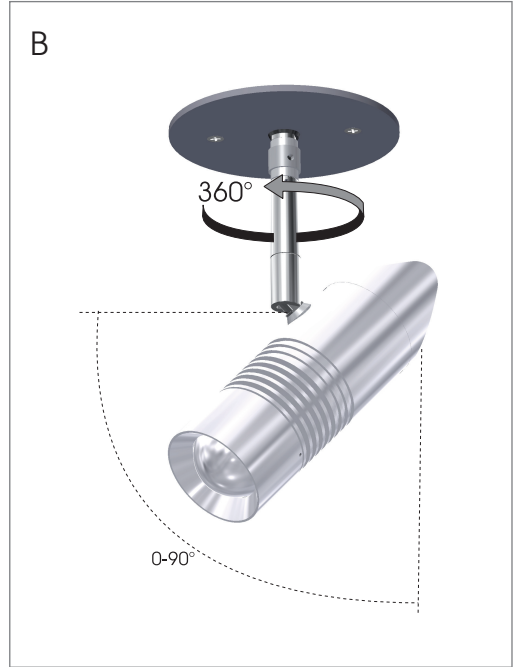

DALI READY

OPTION SMART.POINT : 60-311-10-00 DALI CONVERTER
 OPTION PHASE : D33-624-10-XX DC 24V DALI ADAPTER

HomeMatic READY

OPTION SMART.POINT : 60-312-11-00 HM RF-MODULE
 OPTION SMART.TRACK : 23-625-11-XX HM IQ-MODULE

CASAMBI READY
 Bluetooth 4.0 LE

OPTION SMART.POINT : 60-312-10-00 BT RF-MODULE
 OPTION SMART.TRACK : 23-625-10-XX BT IQ-MODULE

*** DIM** READY

Open Collector / PWM max.20kHz / 5mA / max. DC 24V
 OC Active High / >3V = ON / <2V = OFF / min. Duty Cycle >1µs