

## WALLEY

CHECK-IN





OLIGO Lichttechnik GmbH  
Tannenweg 1  
DE - 53757 Sankt Augustin  
Germany  
www.oligo.de  
info@oligo.de

Art.-Nr. / Item-No.  
**30-858-20-XX** 2-fach

(D)	Leuchtmittel nicht ersetzbar
(GB)	Bulbs not replaceable
(NL)	Lamp niet vervangbaar
(F)	Ampoules non remplaçables
(I)	Lampadina non sostituibile
(ES)	Bombillas no reemplazables
(P)	Lâmpada não substituível
(DK)	Ljuskällorna kan inte bytas ut

(S)	Bulb inte utbytbara
(N)	Lyspærer kan ikke skiftes ut
(FI)	Valistusvälinettä ei voi vaihtaa
(TR)	Ampuller değiştirilemez
(PL)	Źródło światła nie jest wymienne
(GR)	Οι λαμπτήρες δεν αντικαθίστανται
(RUS)	Светодиоды не поддаются замене
(JAE)	تجهيزات الإضاءة غير قابلة للاستبدال

	AC 220-230V / 50-60 Hz	16W	LED /2700K /1060lm /CRI >90
(D)	Spannung	Belastung	Lampe
(GB)	Voltage	Loading	Bulb
(NL)	Spanning	Belasting	Verlichtingsmiddel
(F)	Tension	Charge	Ampoule
(I)	Tensione	Carico	Sorgente luminosa
(ES)	Tensión	Carga	Lámpara
(P)	Tensão	Carga	Lâmpada
(DK)	Spænding	Belastning	Pære
(S)	Spänning	Belastning	Ljuskälla
(N)	Spenning	Fatning	Lampe
(FI)	Jännite	Kuormitus	Lamppu
(TR)	Gerilim	Yük	Lamba
(PL)	Napięcie	Oprawka	Lampa
(GR)	Τάση	Υποδοχή	Λαμπτήρας
(RUS)	Напряжение	Нагрузка	Лампочка
(JAE)	الجهد الكهربى	الدواة	المصباح

	
	
IEC 62471 (EN 62471) <b>RG1 - LOW RISK</b>	
	

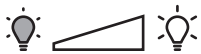
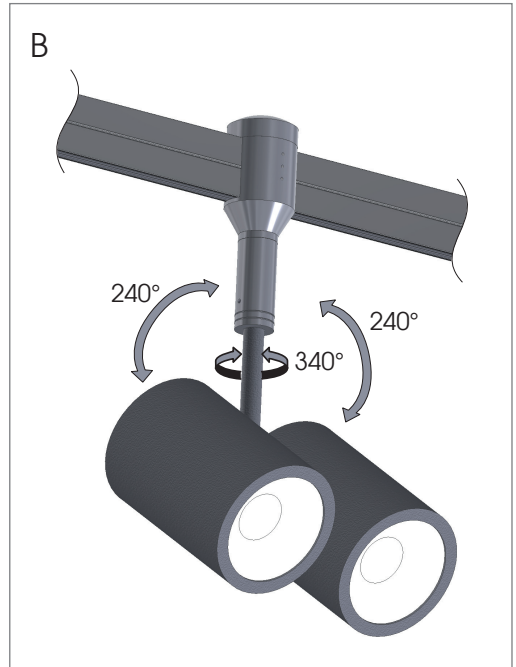

empfohlene Dimmer  
recommended dimmers

- Busch-Jaeger 2247U
- Merten MEG5133
- Merten MEG5136
- Kopp 8033
- Kopp 8078
- Kopp 803402087
- Kopp 803502080
- Jung 225 NV DE
- Jung 225 T DE
- REV Ritter 50141 8851
- REV Ritter 501448551
- Gira 030700
- Homematic IP HmIP-FDT\*
- Homematic IP HmIP-BDT\*

\*  
Minstdimmwert : 30% (~ 10% Helligkeit)  
Minimum dim value : 30% (~ 10% brightness)

Alle Angaben ohne Gewähr und ohne Anspruch auf Vollständigkeit. Bitte beachten Sie die Herstellerangaben.  
No guarantee on correctness and completeness of informations. Please comply with the relevant manufacture's recommendations.